

## Pump-Splitting Using the PROFIRE PC180 Chemical Management System



**Author:** Ozair A. Khan  
Certification Specialist  
Profire Energy

## Introduction

E&P (Exploration & Production) operators need to inject a wide variety of chemicals in wells for a range of applications.

Asphaltenes are heavy constituents of crude oil. They are used to make products like asphalt which is used on road tops. During well operation, they then clog up the reservoir pores near the well boar or even the well tubing due to their heavy physical properties. This causes the well to slow and even stop production depending on the type of crude oil. In order to ramp up production rates again, E&P operators rely on asphaltene dispersants to unclog the wells. Similarly, scale and wax build-ups in wells causes production rates to drop. Injecting scale inhibitors, wax dispersants and wax solvents in wells has shown to be an effective means to counter these.

Microorganisms like bacteria in oil wells might cause many problems. They may cause the growth of aerobic slime which tends to clog the reservoir rock pores and well tubes. They may also result in corrosion and the production of H<sub>2</sub>S. To offset the effects of microorganisms, operators inject biocides which sterilize the bacteria in the wells. Well corrosion is also kept under control by frequent injection of corrosion inhibitors. Another direct way of eliminating H<sub>2</sub>S build-ups in wells is to inject H<sub>2</sub>S scavengers.

A lot of oil production is mixed with water, particularly in mature wells. Methanol is injected to dehydrate the wells and lower its freezing point so that oil continues to flow smoothly.

Sometimes the wells are also injected with soap as a form of foam injection to make the well fluids lighter and allow them to easily travel up the well tube.

On the whole, chemicals are used as maintenance agents and to increase well production in different ways. Depending on the application, sometimes they require continuous injection, and sometimes they are injected batches and at different rates.

Operators always need to keep an eye on their operating budget as overuse of chemicals quickly adds to expenditures.

## Chemical Injection Before CMS

Before the use of chemical management systems (CMS), chemicals were injected in wells in a haphazard manner. When too little chemicals were injected, the well production and maintenance suffered and when too much chemicals were injected, budgets were exceeded, technicians were exposed to hazardous chemicals for longer period of time, and operating and maintenance costs of pumps increased.

There was no systematic way of figuring out exactly how much chemicals were needed in a particular well at a particular time. Sometimes chemicals were injected on an “as needed” basis when emergencies arose. At other times, they were injected at set schedules as part of the wells preventive maintenance, even though the well conditions may have changed since the preventive maintenance schedule was drawn up.

Needless to say, the way things used to be done without CMS led to low production, maintenance problems and were exorbitant in terms of costs. CMS introduced systematic chemical injection in wells so that the operations became effective in terms of production and cost efficiency. Thus, chemical management systems are the answer to the chemical injection dilemma that the industry has always faced.

## The Profire PC180 CMS

Profire Energy's PC180 is the CMS of choice for upstream chemical injection operations. It is an electronic control and monitoring system. It is compatible with almost all existing pumps and it uses chemical injection pumps already found in many well sites.

The PC180 controller can be set up to operate a single pump, in a "pump splitting" configuration or operate multiple pumps. In single pump configuration, it alternates between injection and recycle states. In the injection state, it activates the pump to inject chemicals in the well, while in the recycle state it waits before repeating the process. The figures below show the single pump injection process.

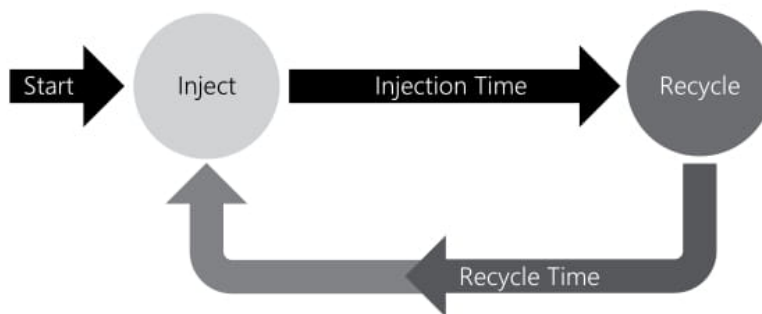
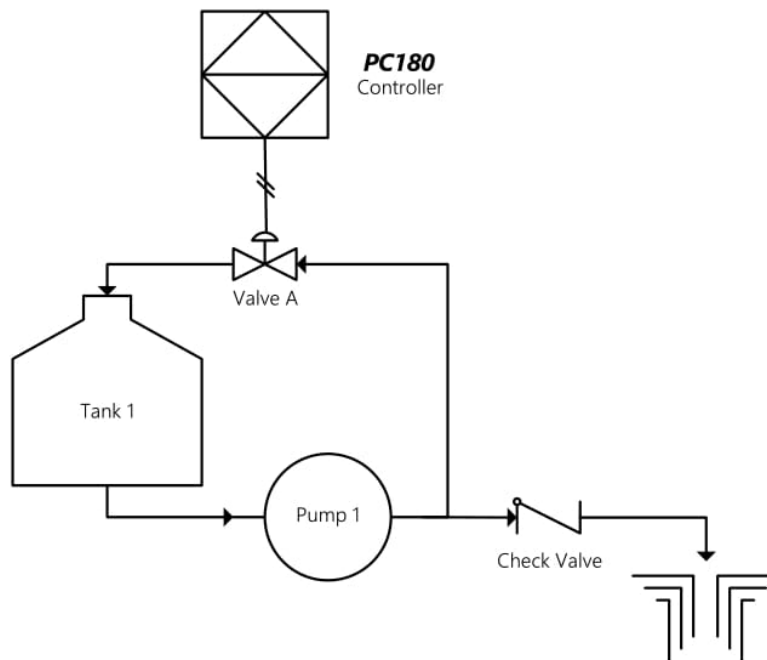

The single pump configuration can be modified to pump chemicals in multiple wells by a process called “pump splitting”. In this scenario, the pump has multiple injection points. The controller multi-tasks the same pump to inject chemicals in different wells through different injection points in a round-robin manner. The figures below show pump splitting.

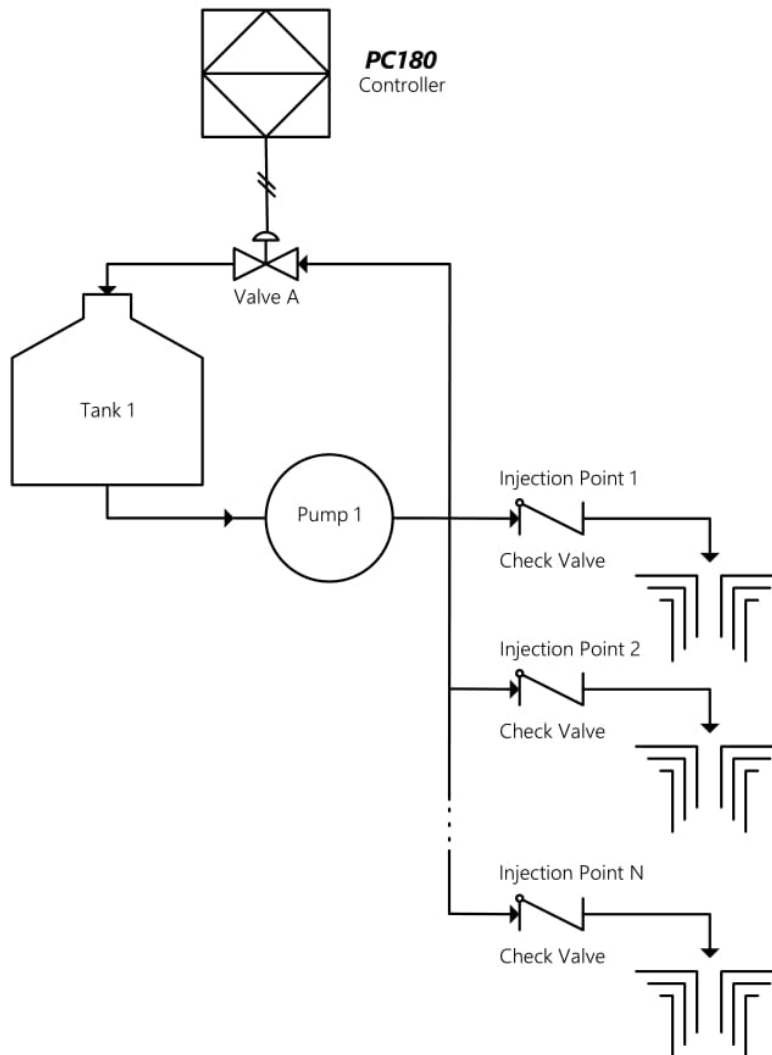

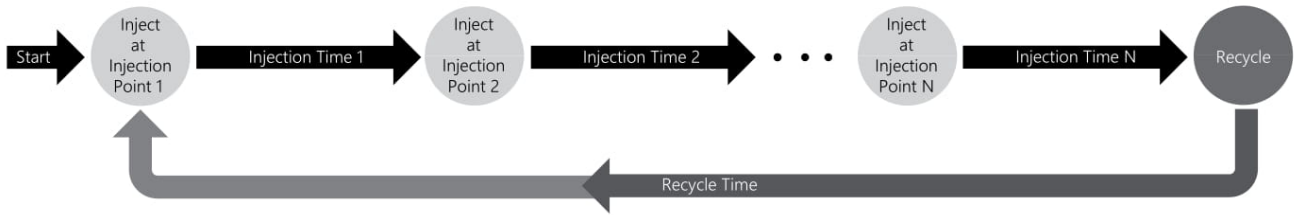

In a multi-pump configuration, each pump is used for each well or one could setup a configuration where some of the pumps are split. The figures below show a multi-pump setup of the PC180.

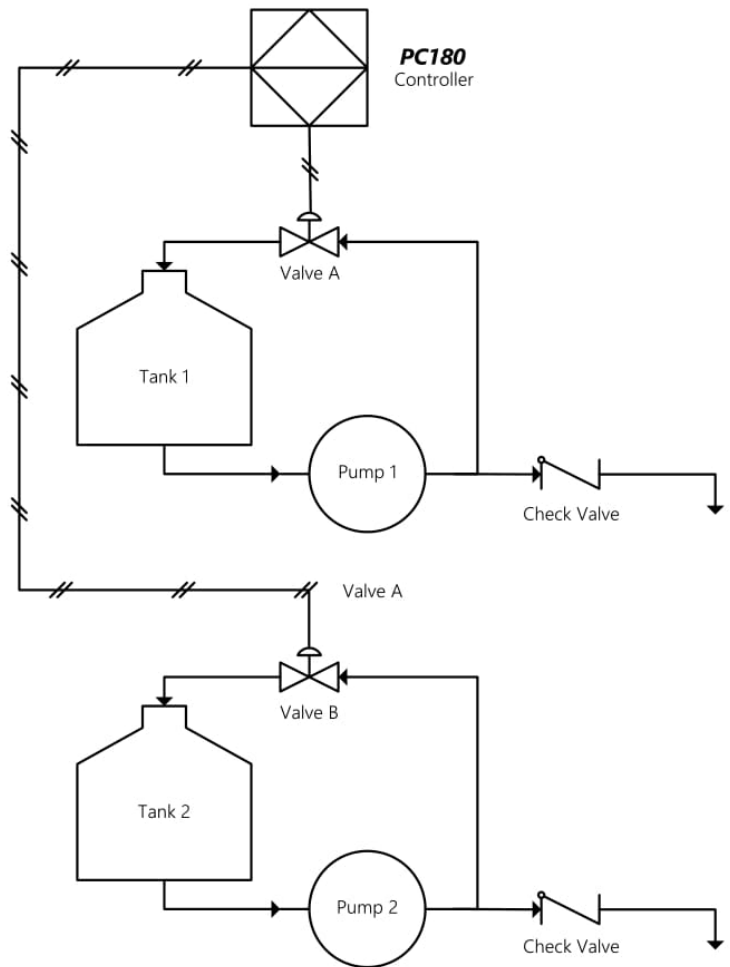

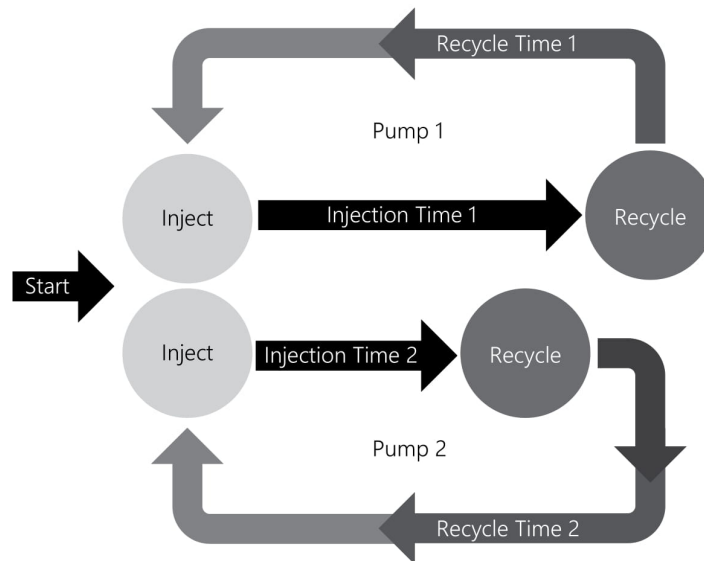

The PC180 can be controlled remotely through the Modbus using the operator’s SCADA (Supervisory Control and Data Acquisition) system. From the comfort of the control room, the operator can change the injection rate of any pump or injection points of the same pump in a pump splitting setup. The operator can also choose to override perpetual injection and shutdown injection at a pump or an injection point completely if they wish.

The PC180 is optimized for changing ambient temperatures. This is ideal for methanol injection, which is pumped more at low temperatures when water tends to freeze. At lower temperatures, the PC180 achieves a higher rate of methanol injection to dehydrate the well. As the temperature increases, the injection rate decreases correspondingly on-the-fly to match what is required.

Artificial lift optimization is also built into the PC180. The controller injects chemicals at a certain rate when the well is closed and builds up pressure for the hydrocarbons inside the well as the injected chemicals decrease flow impedance. When the well opens for the hydrocarbons to flow again, the controller senses this and changes the chemical injection rate to what is needed synchronously. The figure that follows shows how artificial lift optimization works in the PC180.

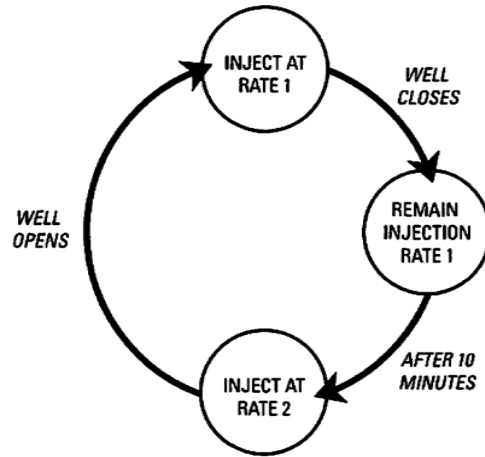

H<sub>2</sub>S scavenging operations are also automated by the PC180. The controller constantly monitors the H<sub>2</sub>S level in the well. If it goes above the acceptable threshold, the rate of H<sub>2</sub>S scavenger injection is increased, while if it goes below that threshold, the rate is decreased accordingly. The figure below summarizes how H<sub>2</sub>S scavenging works using the PC180.

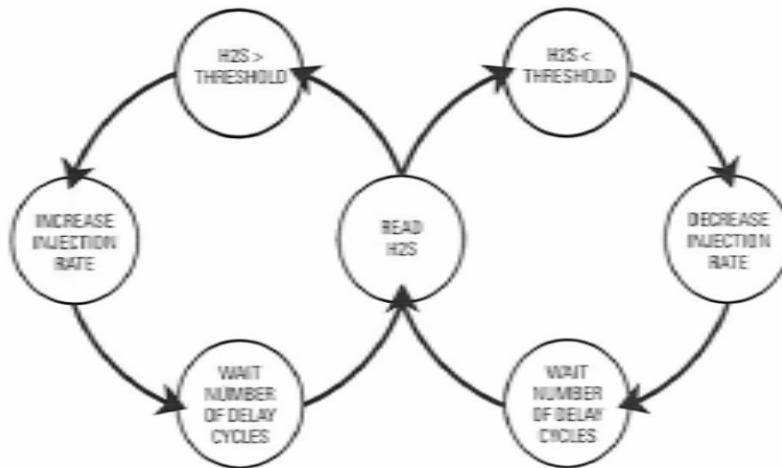

The common feature concerning all these chemical injection rate controls is that it is not binary, instead it changes smoothly with feedback from sensors monitoring well conditions. This allows the most optimum use of chemicals for any particular condition.



## Case Study

A major oil company in the Devonian play in northern Alberta was facing problems with methanol injection in wells. They were initially trying to split the flow from one pump to four well heads by using four needle valves. They found that the flow was going to the lowest pressure well through the path of least resistance.

The company requirements were:

- A system that would split the flow to each well head with the ability of having different rates for each well.
- Remote control of injection rates through MODBUS for the operators and the ability to automatically shut off an injection point.

Profire Energy supplied and installed a PC180 CMS to address these.

With the PC180 we were able to meet all their needs:

- 4 injection points with one pump utilizing a recycle valve for rate control;
- Precision rate control to each injection point;
- Each injection point was provided its own rate;
- If a well is shut in, that injection point rate gets allocated to recycle;
- Full MODBUS control for remote rate changes and control;
- The ability to set each injection point rate via the PC180 key pad or through MODBUS.



## Conclusion

Using the PC180, Profire's customers achieved all the known benefits of CMS including using the exact amount of chemicals that were required – not too much and not too little. They also achieved smooth variance of injection rates with the changing well conditions. Thus, they saved money while solving their production and maintenance issues.

Furthermore, pump splitting allowed the use one pump instead of many. Not only did the PC180 save in the cost of additional pumps, but it saved on their maintenance and fuel expenses which are increasing due to the carbon tax (which has become a recent concern in Alberta). Having one pump also decreased the footprint in the oil field where stringent safety distances from facilities causes congestion problems which lead to hazards. One pump is easy to set up and ideal to operate in a well pad where wells are close together. Remote control through SCADA enabled the operators to control operations without exposing themselves to the hazards of the field. It also reduced transportation costs and time in the field, as visits to the well site were reduced.